

TD020-RGBW

Deck Light

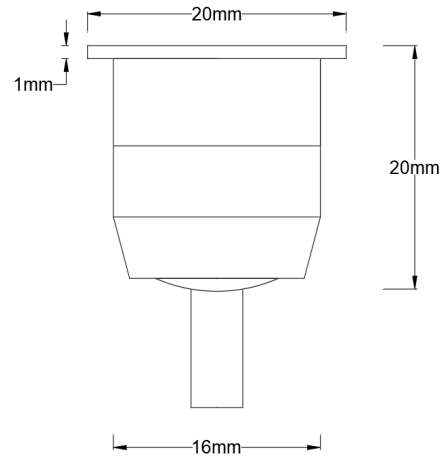

Product Data

Voltage:	24 Volt DC Constant Voltage
Wattage:	0.8 Watts
IP Rating:	IP65
LED:	RGBW
Cable:	5-Core, 0.5m
Faceplate:	20mm
Material:	6063 anodised aluminium
Lamp Life:	30,000 Hours
Cut-out:	16mm
Warranty:	2 Years

Disclaimer: While every care has been taken with the details of these products, Specialised LED Products Ltd accepts no responsibility for any inaccuracies. Specialised LED Products Ltd reserves the right to change the specifications without notice to continually ensure you receive a superior product.

innovative lighting solutions

